	

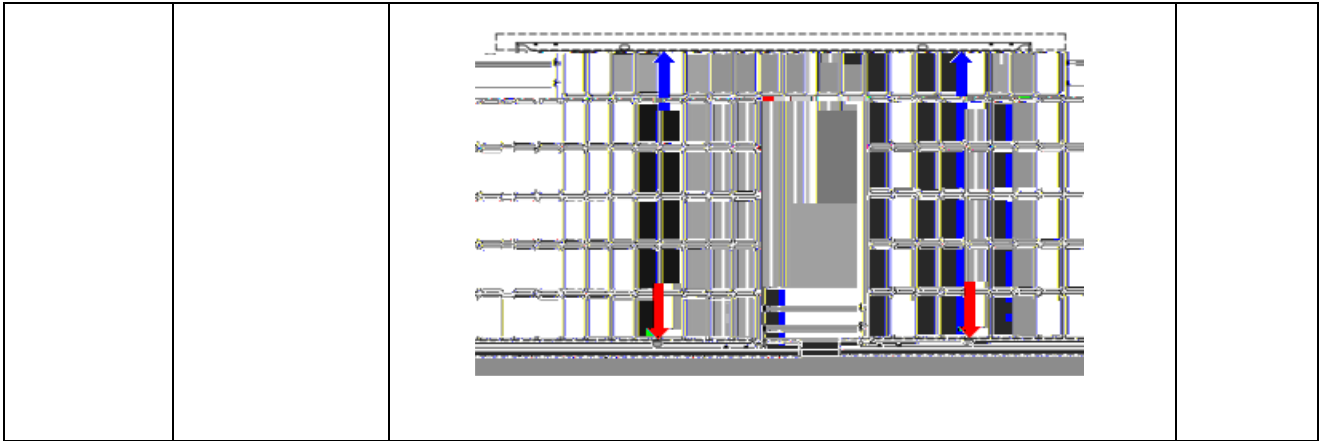

--	--	--	--



4

3

4

5

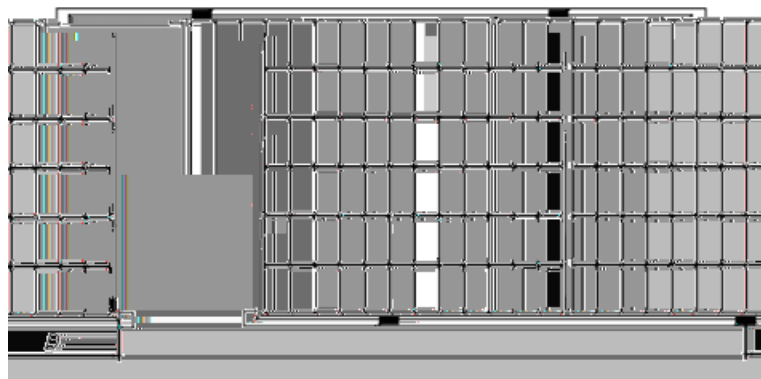

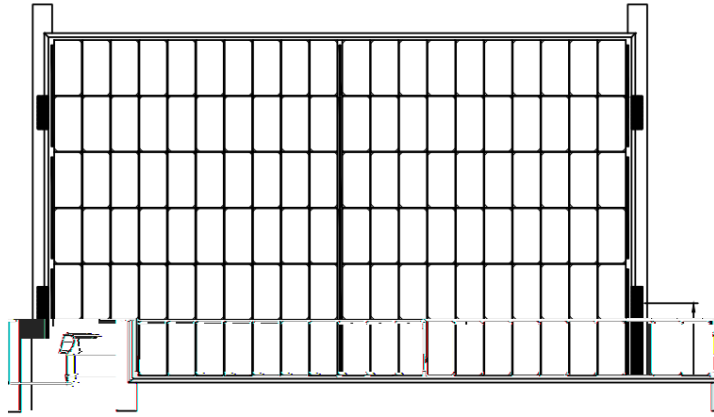
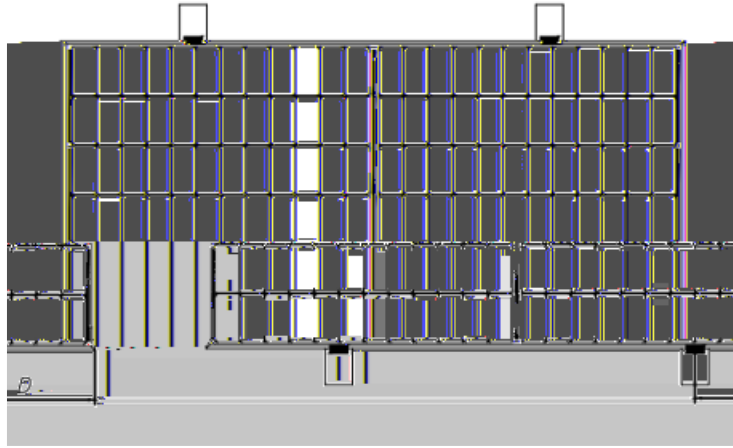

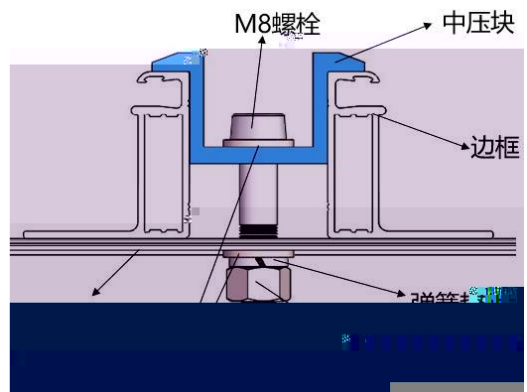
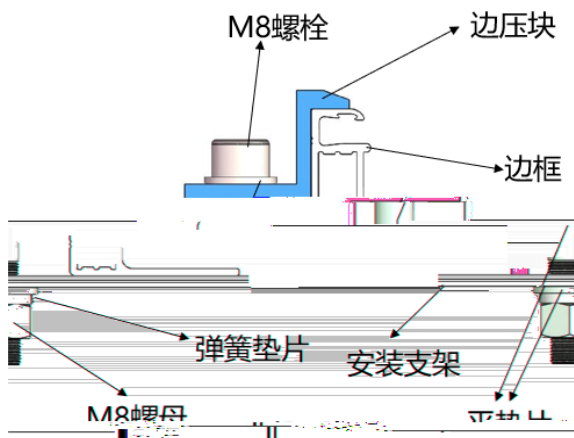
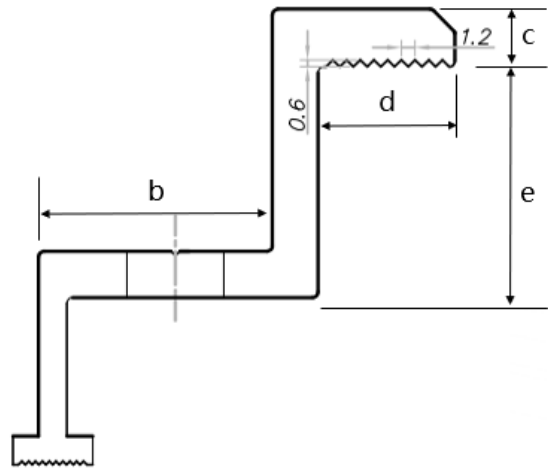
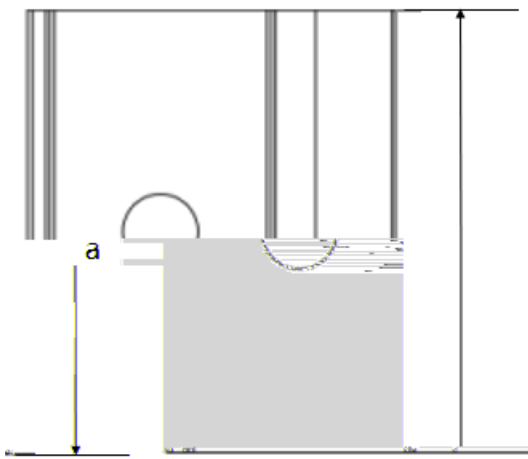

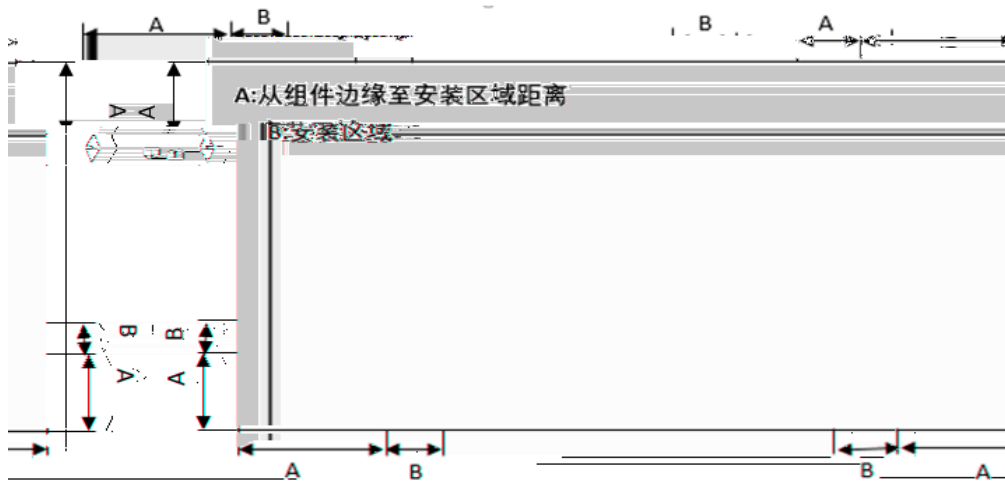





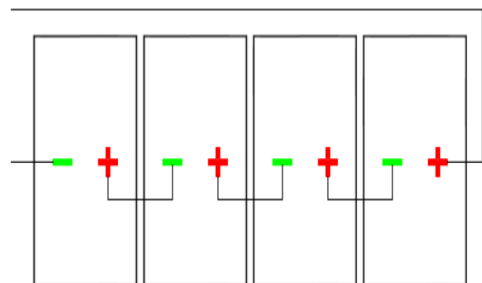
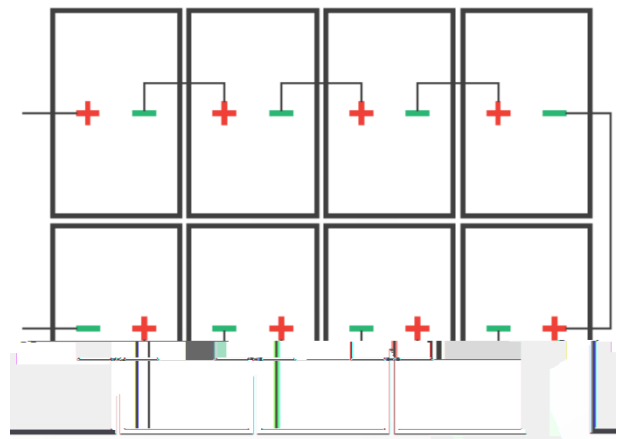
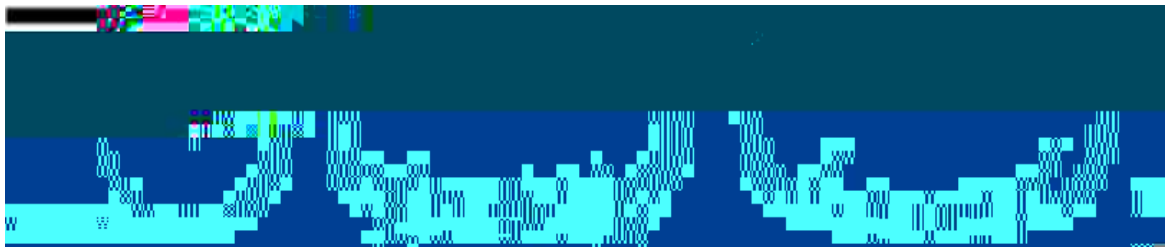



	示图	连接方式
		<p>将星形垫圈、平垫圈和接地线依次放置，使用螺钉穿过接地孔，再将其拧紧来固定相邻组件。</p>

2.

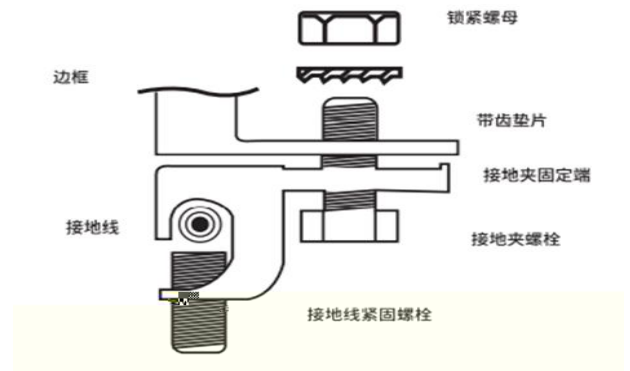

3.



